

1

2

3

4

5

6

A

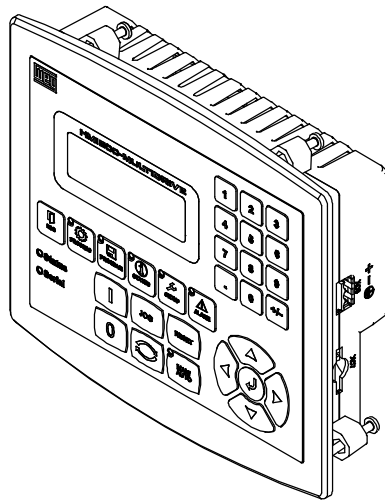

B

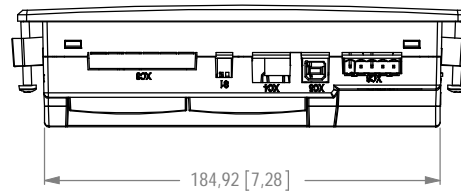

C

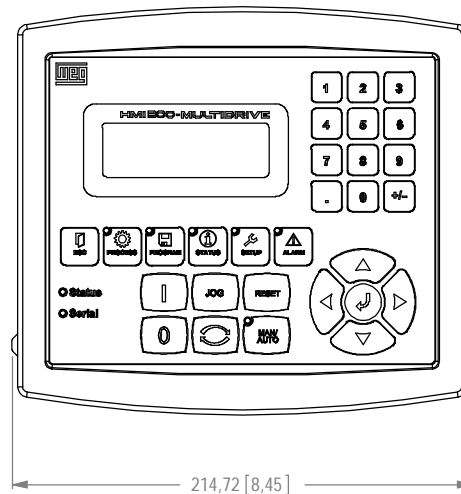
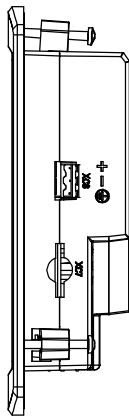

D

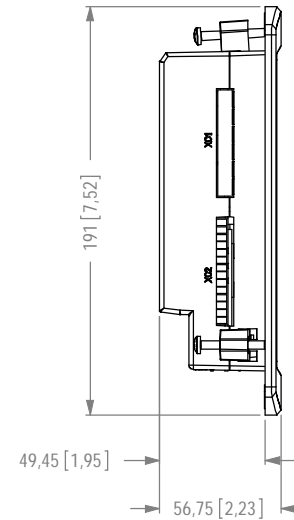

E

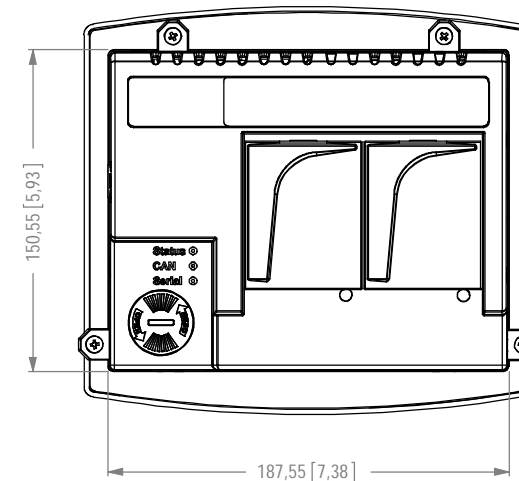
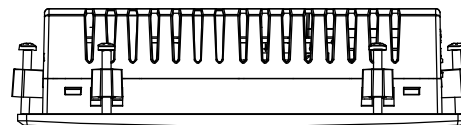

MASSA BRUTA/GROSS WEIGHT		VER MANUAL / DATA SHEET		MASSA LÍQUIDA/NET WEIGHT		VER MANUAL / DATA SHEET		ESCALA/SCALE	
500000500438		ELABORAÇÃO INICIAL							
EXEC	EMERSON	RESUMO DE MODIFICAÇÕES SUMMARY OF MODIFICATIONS		EXECUTADO EXECUTED	VERIFICADO CHECKED	LIBERADO RELEASED	DATA DATE	VER	
VERIF/CHECKED	SABRINA	HMI300 - MULTIDRIVE				10001392527			
LIBER/RELEASED	JUAREZ								
DT LIBER/REL DT	12/08/2011	WAU	JARAGUA DO SUL	DESENVOLVIMENTO ELETRONICO	FOL/SHEET	1 / 1			

